

VI.VI

CellAdvisor™

JD746B/JD786B RF Analyzers



www.cdip.ru
info@cdip.ru

+7 (495) 956-20-22

Introduction

A CellAdvisor JD746/JD786B RF analyzer is the optimal test tool for installing and maintaining cell sites. It contains all the features and capabilities required for field testing cell sites for all 2G to 4G wireless technologies.

Equipped with one-button standards-based measurements for wireless signals, the analyzer offers a full scope of BTS conformance tests. Its combined functionality includes spectrum analysis, cable and antenna analysis, an RF/optical power meter, interference analysis, a channel scanner, RFoCPRI™, and signal analysis.

Standard features include:

- Spectrum analyzer
- Cable and antenna analyzer
- RF power meter

Advanced features include:

- Interference analysis
- Channel scanner
- 2-port transmission
- CW signal generator
- RFoCPRI
- GPS receiver
- Built-in bias tee
- Optical power meter
- Fiber inspection with pass/fail (requires P5000i microscope)*
- Cloud Enabled via StrataSync™*

Highlights and capabilities include:

- Passive intermodulation (PIM) detection
- Dual spectrum
- Spectrum replay
- Dual spectrogram
- Remote control
- Coverage mapping
- Remote wireless connectivity via Bluetooth®

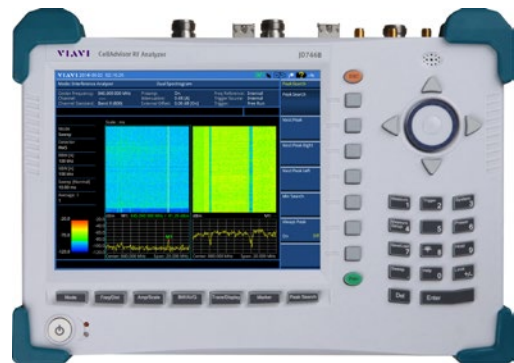

JD746B RF Analyzer

Spectrum analyzer	100 kHz to 4 GHz
Cable and antenna analyzer	5 MHz to 4 GHz
RF power meter	10 MHz to 4 GHz

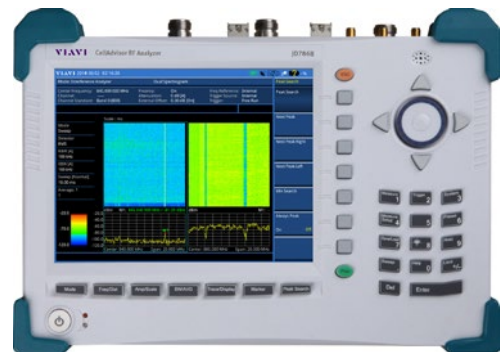

JD786B RF Analyzer

Spectrum analyzer	9 kHz to 8 GHz
Cable and antenna analyzer	5 MHz to 6 GHz
RF power meter	10 MHz to 8 GHz

* CellAdvisor JD786B only

Features

Easy User Interface

The analyzer provides a consistent, intuitive interface throughout its various functions, giving users a common, easy-to-use menu structure.

The analyzer's built-in help system guides users through each measurement task. They can save a screenshot of any function as a graphic file for report generation and save traces for post-analysis to the instrument's internal memory or to an external USB memory device. Stored data can be easily transferred to a PC using the USB or Ethernet port.

Users can edit file names using the instrument's rotary knob that also conveniently functions as an enter button when selecting alphanumeric characters.

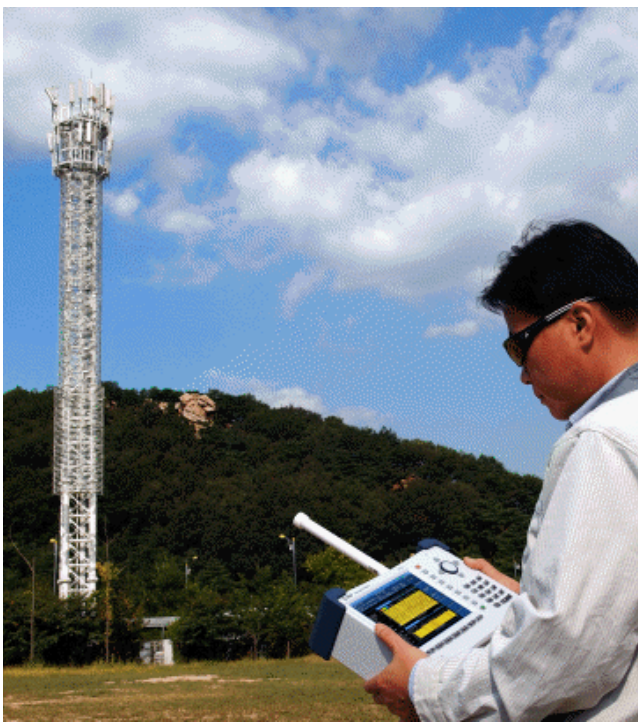

The outdoor display mode enables easier reading in direct sunlight

Designed for Field Use

The compact, lightweight analyzer is especially convenient for users who perform field measurements.

Its bright, multimode, 8-inch color display enables clear visibility indoors and outdoors.

The operating temperature ranges from -10 to 55°C; and, its rugged bumper protects the instrument from external impacts exceeding the MIL-PRF-28800F class 2 specification.

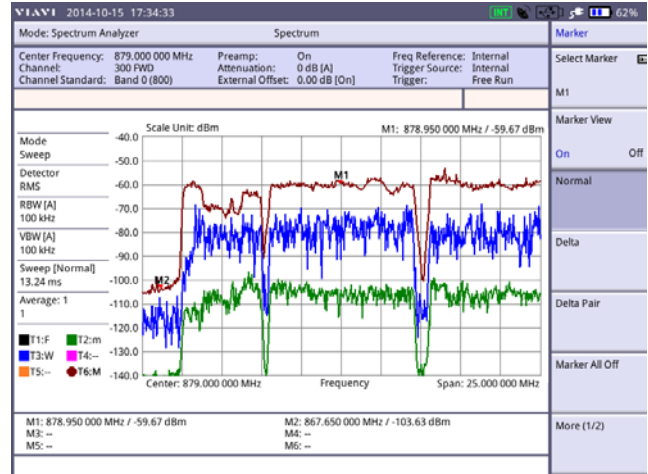

Outdoor display mode

RFoCPRI

Modern cell sites have a distributed architecture that replaces coax-based feeders with fiber-based feeders and, therefore, significantly reduces signal loss and reflection problems. However, since all RF interfaces reside on the RRH, any RF maintenance or troubleshooting requires reaching the tower top to gain access to the RRH, which increases safety concerns and operational expenses.



The Viavi RFoCPRI reduces risky cell tower climbs letting technicians test safely from the ground

RFoCPRI technology enables cell technicians to verify the CPRI control signals and extracts the RF (IQ) data transmitted between the BBU and RRH at the ground without the need to climb the tower. Key benefit of RFoCPRI is that it enables monitoring and analyses of mobile terminal (uplink), PIM detection, as well as the radio's signal (downlink) interference over a CPRI link.

Integrated Functionality

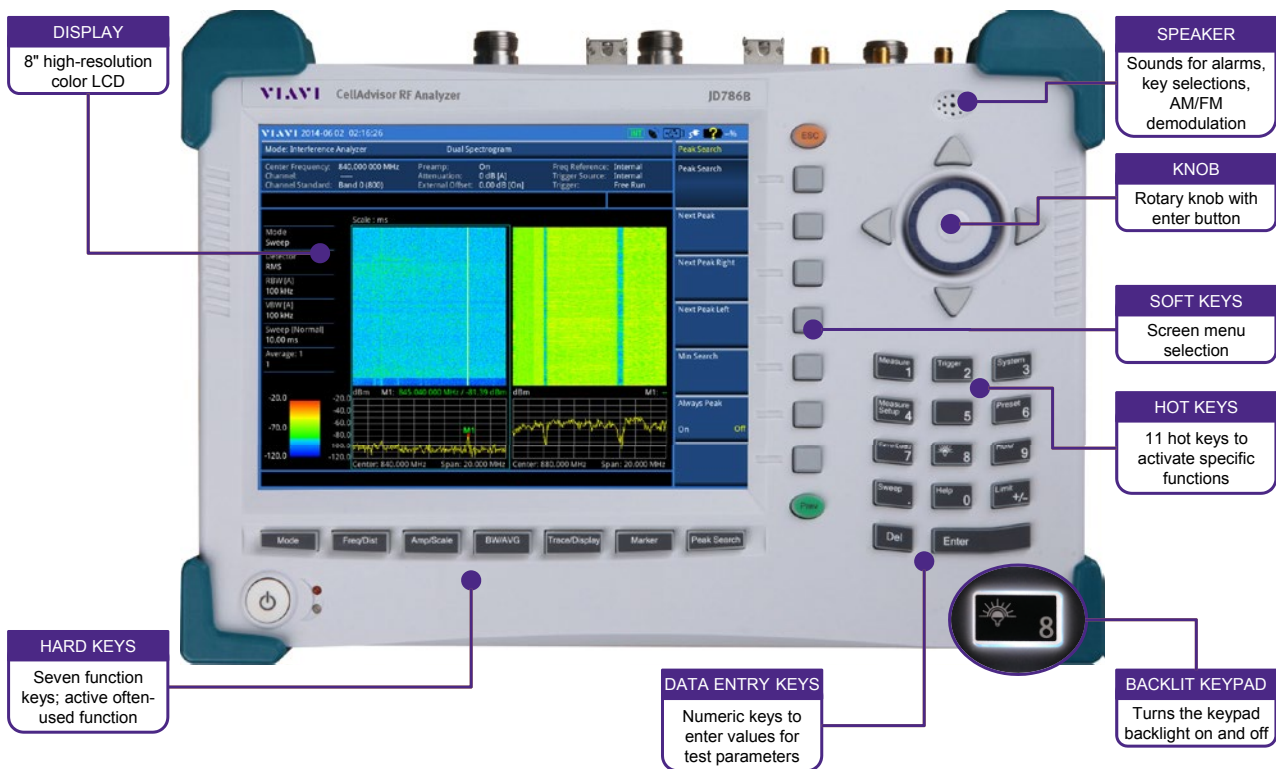
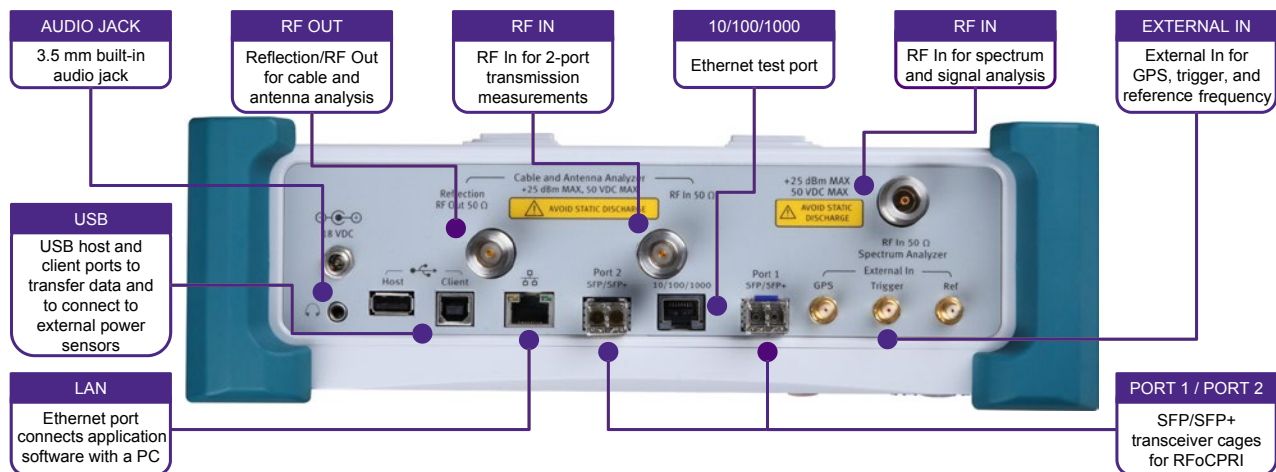

Spectrum analyzer 100 kHz to 4 GHz (JD746B) 9 kHz to 8 GHz (JD786B) Built-in pre-amplifier Zero span with gate sweep	Locates and identifies various signals. Detects signals as low as -160 dBm/-165 dBm with better than 1 dB measurement accuracy. Triggers pulse or burst signals such as WiMAX, GSM, and TD-SCDMA.
Cable and antenna analyzer 5 MHz to 4 GHz (JD746B) 5 MHz to 6 GHz (JD786B)	Provides cable and antenna characterization for proper power transfer from the radio to the antenna. Locates failure points for effective troubleshooting. Verifies conformance to cable specifications.
RF power meter 10 MHz to 4 GHz (JD746B) 10 MHz to 8 GHz (JD786B)	Integrated RF power meter eliminates the need for a separate instrument and measures power with or without a power sensor.
2-port transmission measurements (option 001)	Verifies passive and active devices such as filters and amplifiers.
Bias tee (option 002)	Supplies up to 32 VDC built-in bias to active devices such as amplifiers.
CW signal generator (option 003)	Provides a sine wave or continuous wave (CW) source for measurements such as those used for isolating a repeater.
RFoCPRI/interference analyzer (option 008, 060-065)	Enables RF measurements over CPRI without the need to climb the tower to access the remote radio head
Bluetooth connectivity (option 006)	Provides remote control and monitoring capability with JDRemote via Bluetooth interface.
GPS receiver and antenna (option 010)	Provides geographical location and highly-accurate frequency, and time for precise measurements.
Interference analyzer (option 011)	Provides the required spectrogram and multisignal RSSI parameters to properly monitor, identify, and locate interference signals. In addition, it can generate a variable audible tone based on signal strength.
Channel scanner (option 012)	An intuitive graphical representation of the signal's power for each of the 20 user-definable carriers (frequencies or channels) enables quick identification of improper power levels.
Optical power meter	Measures optical power for all single-mode and multimode connectors via an optical power sensor (MP-60A or MP-80A).

Spectrum Analyzer

The analyzer is the most flexible general purpose spectrum analysis test tool for monitoring and analyzing the RF spectrum. The Spectrum Analysis function performs these one-button standards-based wireless-signal power measurements:

- Channel power
- Occupied bandwidth
- Spectrum emission mask
- Adjacent channel power
- Spurious emissions
- Field strength
- AM/FM audio demodulation
- Route map
- PIM detection
- Dual spectrum

Capabilities

- Built-in preamplifier
- Zero span with gated sweep
- AM/FM audio demodulation
- Multiple detectors: normal, RMS, sample, negative, peak
- Advanced marker: frequency counter, noise marker
- Limit line
- Up to six markers and six traces

Measurements

Channel Power measures the power level, spectral density, and peak-to-average ratio (PAR) of the signal in a specified channel bandwidth, showing pass/fail for the defined power



RF test — Channel Power

Occupied BW measures the frequency bandwidth that contains the specified percentage of the power, the total integrated power, and the occupied power with pass/fail results for the defined bandwidth.

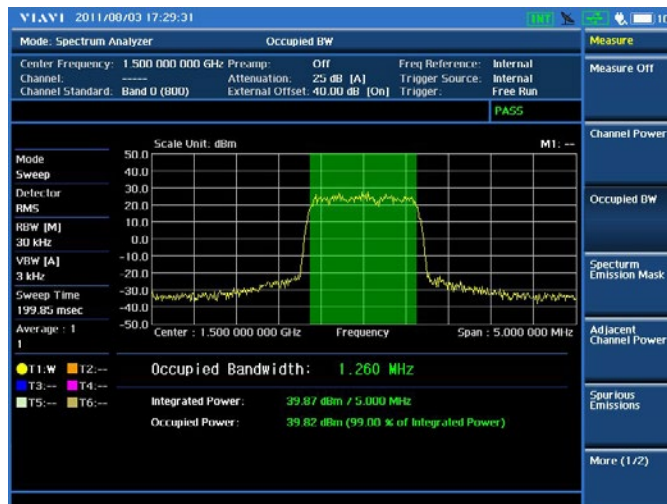

RF test — Occupied Bandwidth

Spectrum Emission Mask (SEM) compares the total power level within the defined carrier bandwidth and the given offset frequencies to defined mask limits with pass/fail results.

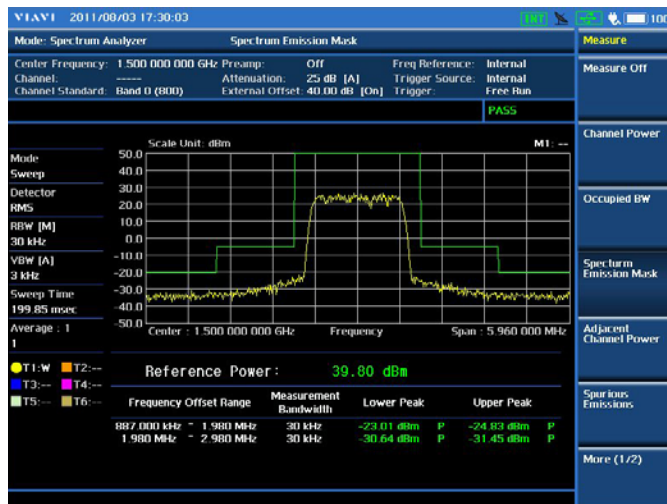

RF test — Spectrum Emission Mask

Adjacent Channel Power (ACP) measures the amount of RF power leakage in adjacent channels and its ratios, with pass/fail results for the defined test condition.



RF test — Adjacent Channel Power

Spurious Emissions measurements identify and determine the power level of spurious emissions in certain frequency bands, showing pass/fail results based on the defined mask limits.

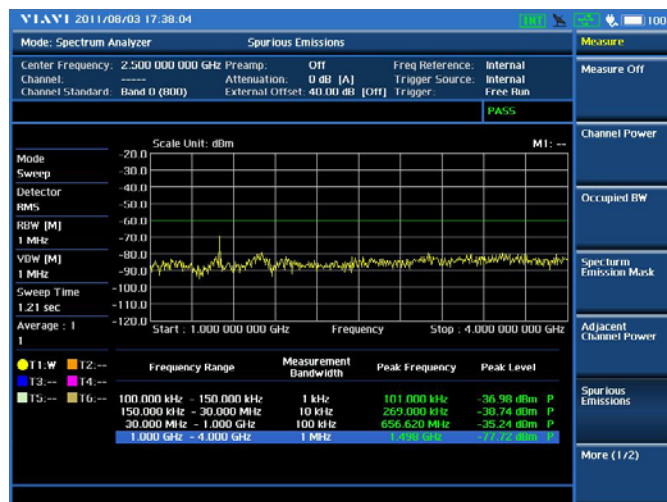

RF Test — Spurious Emissions

Field Strength quickly and conveniently measures and analyzes field strength to user-definable multisegment lines. Measuring field strength is easy once the user specifies the antenna factors in the analyzer.

AM/FM Audio Demodulation identifies interfering signals. The AM/FM signal can be demodulated into the instrument's built-in speaker or through a headset.

The spectrum analyzer can simultaneously operate with the CW signal generator. It easily fulfills the >100 dB guideline required for measuring repeater and antenna isolation.

PIM Detection identifies passive intermodulation in the uplink band caused when signals are combined and transmitted on a single nonlinear feed line.



RF test — PIM Detection

Dual Spectrum lets users view the spectrum activity for two different uplink and downlink spectrum bands on one screen simultaneously rather than switching between screens.

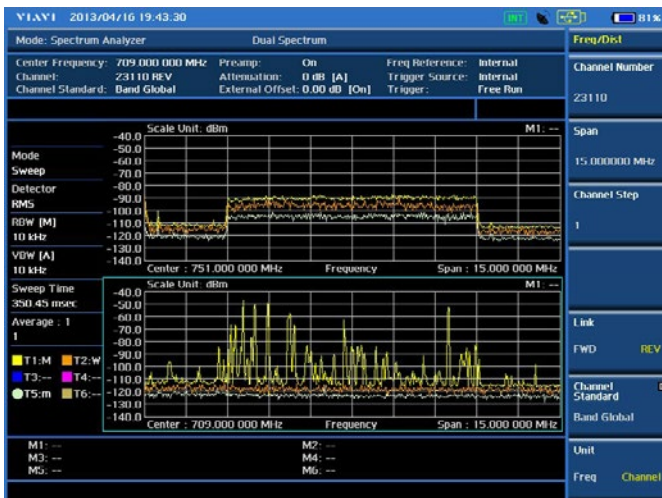

RF test — Dual Spectrum

Cable and Antenna Analyzer

The analyzer performs cable and antenna measurements to verify the base station's infrastructure, including feed lines, connectors, antennas, cables, jumpers, amplifiers, and filters.

Capabilities

- Reflection
 - Voltage standing-wave ratio (VSWR)
 - Return loss
- DTF
 - VSWR
 - Return loss
- Cable loss (1-port)
 - Scalar measurements
 - Vector measurements
- Port phase
- Smith chart
- 2-port transmission measurements (option 001)
 - Scalar measurements
 - Vector measurements

Measurements

Reflection – Return Loss measures complete cell-site transmission line impedance performance across a specific frequency range in VSWR or return loss.

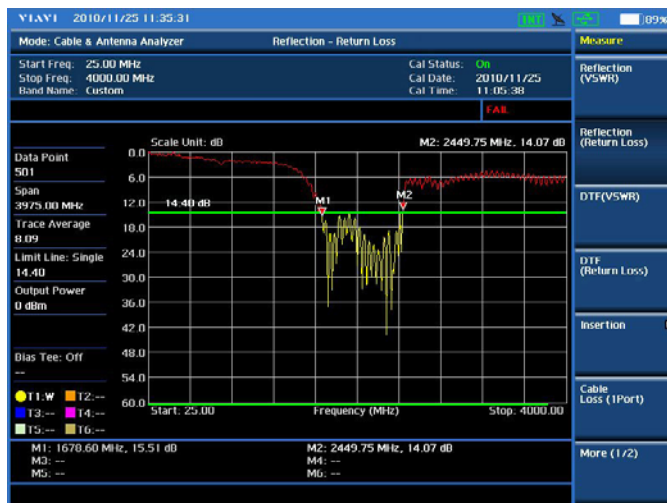

Cable and antenna test — Reflection

DTF – Return Loss measures fault locations in the cell-site transmission system indicating signal discontinuities in VSWR or return loss. This distance-to-fault measurement precisely pinpoints the location of such things as damaged or degraded antennas, connectors, amplifiers, filters, and duplexers.



Cable and antenna test — Distance to Fault

Cable Loss (1 port) measures the signal loss through a cable or other devices over a defined frequency range by connecting one end of the cable to the instrument measurement port and terminating the other end of the cable with a short, or leaving it open altogether.



Cable and antenna test — Cable Loss

Smith Chart measures impedance and phase to properly tune RF devices. Smith Chart also displays impedance-matching characteristics in cable and antenna systems or filter and duplexer devices.



Cable and antenna test — Smith Chart

1-Port Phase measures S_{11} phase to tune antennas and to phase-match cables.



Cable and antenna test — 1-Port Phase

2-Port Measurement (Scalar) (option 001) have vector and scalar measurements. Scalar measurement provides greater dynamic range (>100 dB); vector measurement provides greater accuracy and faster test time.



Cable and antenna test — 2-port Measurement

Insertion Gain/Loss measures the characteristics of passive and active devices such as filters, jumpers, splitters, and amplifiers and verifies antenna or sector-to-sector isolation.

2-Port Phase in Vector Measurements measure S_{21} phase to characterize transmission devices such as filters and amplifiers.

The optional built-in bias-tee supplies power to active devices through the instrument's RF In port, eliminating the need for an external power supply.

Power Meters

The analyzer is equipped with an RF power meter and an optical power meter.

The RF power meter performs two different methods of power measurement. The first is an internal power measurement for standard power testing without the assistance of external power sensors and the second interfaces with an external power sensor for high-accuracy power measurements.

The optical power meter measures optical power for single-mode and multimode connectors via an external optical power sensor.

RF Power Meter (standard)

Internal power measurement

- Frequency range: 10 MHz to 4 GHz/8 GHz
- Dynamic range: -120 to +20 dBm/+25 dBm
- Measurement type: RMS or peak

External power measurement

- JD732B: Terminating power sensor (average)
 - Frequency range: 20 MHz to 3.8 GHz
 - Dynamic range: -30 to +20 dBm
- JD734B: Terminating power sensor (peak)
 - Frequency range: 20 MHz to 3.8 GHz
 - Dynamic range: -30 to +20 dBm
- JD736B: Terminating power sensor (average and peak)
 - Frequency range: 20 MHz to 3.8 GHz
 - Dynamic range: -30 to +20 dBm
- JD731B: Directional (through line) power sensor
 - Frequency range: 300 MHz to 3.8 GHz
 - Dynamic range: average 0.15 to 150 W, peak 4 to 400 W
 - Measurement:
 - Forward average power
 - Reverse average power
 - Forward peak power
 - VSWR
- JD733A: Directional (through line) power sensor
 - Frequency range: 150 MHz to 3.5 GHz
 - Dynamic range: average/peak 0.1 to 50 W
 - Measurement:
 - Forward average power
 - Reverse average power
 - Forward peak power
 - VSWR

Optical Power Meter

Miniature USB 2.0 optical power sensors

- MP-60A
 - Wavelength range: 780 to 1650 nm
 - Dynamic range: 1300, 1310, 1490, 1550 nm: -50 to +10 dBm
850 nm: -45 to +10 dBm
- MP-80A
 - Wavelength range: 780 to 1650 nm
 - Dynamic range: 1300, 1550 nm: -35 to +23 dBm;
850 nm: -30 to +23 dBm

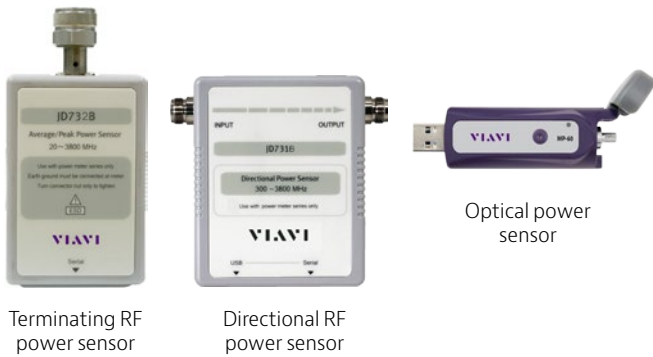

The power meter analysis has user-definable pass/fail limits and displays test results in dBm and watts. Power measurements can be set as absolute measurements displayed in dBm or as relative measurements displayed in dB.

The analyzer displays power levels in two formats, as a real-time value in an analog meter and as a power-level trend through time in a histogram chart.



Power meter test (RF or optical)

* CellAdvisor JD786B only

JD730-series high-precision RF power sensors measure RF power connected via USB to the analyzer.

The analyzer controls terminating power sensors (JD732B, JD734B, and JD736B), making it a highly accurate RF power meter for out-of-service applications up to 3.8 GHz with a -30 to +20 dBm measurement range.

The analyzer controls directional power sensors (JD731B and JD733A) measuring output power and impedance matching for in-service systems. These power sensors can handle up to 150 W of power, eliminating the need for attenuators.

The analyzer controls optical power sensors (MP-series) to measure optical power quickly and easily in single-mode or multimode.

This optical power meter offers a well-organized solution for fiber inspection.

Fiber Inspection* eliminates the most common fiber link problems by verifying that connectors are not contaminated. Only the JD786B can quickly and easily troubleshoot and certify fiber connection quality and cleanliness. Connecting the optional P5000i Fiber Microscope lets users quickly inspect and clean fiber connections with a clear pass/fail indication. The free FiberChekPRO™ application can be used on a PC/laptop with the P5000i microscope to perform the same fiber analysis in parallel using the instrument to test RF and using the PC/laptop to test fiber. Users also can inspect, test, and certify any fiber connector and instantly generate comprehensive pass/fail summary reports.



P5000i microscope

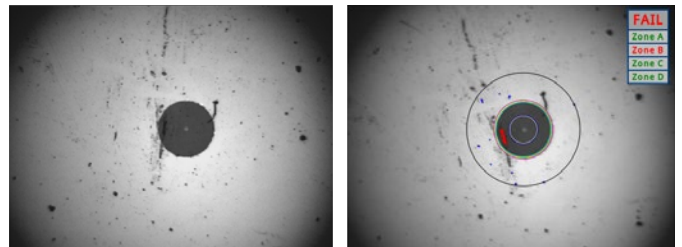

Fiber passed

Fiber failed

Interference Analyzer

The Interference Analyzer (option 011) function is extremely effective for locating and identifying periodic or intermittent RF interference. Interference signals derive from several kinds of licensed or unlicensed transmitters that cause dropped calls and poor service quality.

- Spectrum analyzer
 - Sound indicator
 - AM/FM audio demodulation
 - Interference ID
 - Spectrum recorder
- Spectrogram
- Receive signal strength indicator (RSSI)
- Interference finder
- Spectrum replayer
- Dual spectrogram

Measurements

A spectrum analyzer can perform spectrum clearance, capturing just the events where the received signal exceeds the defined power limit.

The audible tone volume is proportional to the signal's power strength. In addition, a built-in AM/FM audio demodulator conveniently identifies AM/FM signals.

Interference ID automatically classifies interfering signals and lists the possible signal types corresponding to the signal selected.

Spectrogram captures spectrum activity over time and uses various colors to differentiate spectrum power levels.

The spectrogram is effective for identifying periodic or intermittent signals. Post-processing analysis can be made for each measurement over time using a time cursor.

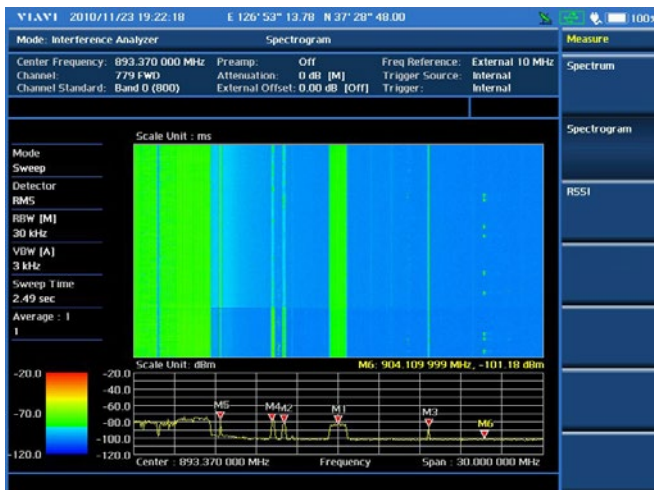

Interference analysis test — Spectrogram

RSSI is a multisignal tracking metric that is particularly useful for measuring power-level variations over time.

The RSSI measurement lets you assign a power limit line for audible alarms and increase alarm counters every time a signal exceeds a defined limit line.

For long-term analysis, the spectrogram and RSSI measurements can be automatically saved into an external USB memory. Post-analysis can be performed with JDViewer application software.



Interference analysis test — RSSI

Interference Finder is an automatic triangulation algorithm that uses GPS coordinates to locate possible interference sources based on three measurements.

The interference finder calculates possible interference locations using its inscribed circle or circumscribed circle based on measured intersection points.



Interference analysis test — Interference Finder

Spectrum Replayer lets users retrieve and replay recorded spectrum analyzer traces in interference analysis mode. These traces can be played back in the spectrogram or RSSI.

Users can configure the limit line to create failure points when signals exceed it. The failure points are clearly displayed on the trace timeline for quick access during playback.

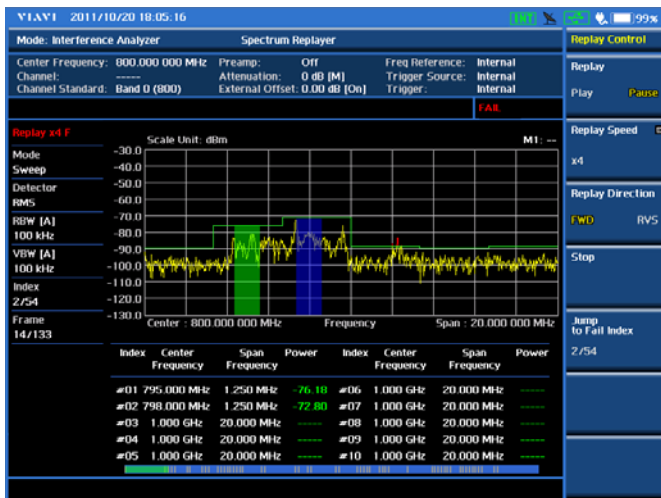

Interference analysis test — Spectrum Replayer

Dual Spectrogram captures the spectral activities for two different bands over time to identify periodic or intermittent band signals.



Interference analysis test — Dual Spectrogram

RFoCPRI

The analyzer measures RF over CPRI to monitor the CPRI link status between REC (BBU) and RE (RRH), and it can emulate the REC to verify the RRH cabling and operational status at the ground via fiber.

Capabilities

- Layer-2 monitoring
- Layer-2 term
- Interference analyzer
 - Spectrum analyzer
 - Sound indicator
 - AM/FM audio demodulation
 - Interference ID
 - Spectrum recorder
- Spectrogram
- RSSI
- Spectrum replayer
- PIM detection
 - Single radio
 - Multiple radios

Measurement

Layer-2 Monitoring is an in-service measurement that enables monitoring of the Layer-1 link maintenance alarms delivered on the Layer-2 L1 in-band protocol as well as optical power being received.



RFoCPRI — Layer-2 Monitoring

Layer-2 Term is an out-of-service measurement that also enables monitoring of the Layer-1 link maintenance alarms delivered on the Layer-2 L1 in-band protocol as well as optical power being received. Another benefit of this function is to emulate the baseband unit and support the start-up process of the RRH so users can verify the optical cabling and proper RRH operation at the ground.



RFoCPRI — Layer-2 Term

Interference Analyzer

Interference analyzer captures I/Q data from the CPRI link and shows the uplink and downlink spectrum. RFoCPRI does not require tower climbs to locate and identify interference signals present on the uplink band.

Spectrum Analyzer enables users to see and record the uplink and downlink spectrum for further analysis later. It provides a more effective way to observe interference for TDD systems because it completely separates the uplink signal from downlink.

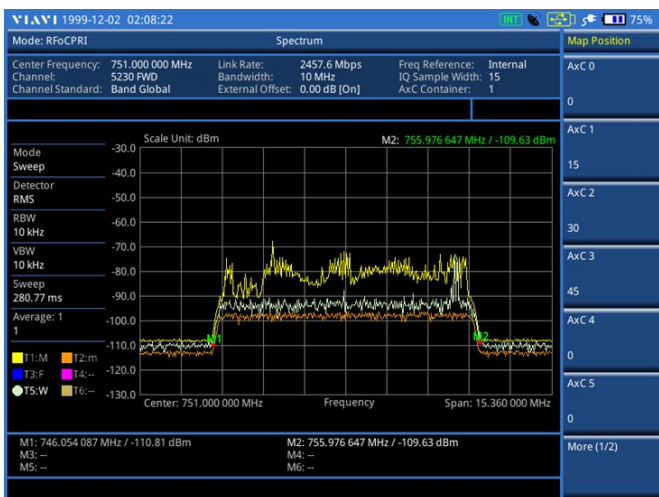

RFoCPRI — Spectrum

Spectrogram captures spectrum and displays it as a waterfall diagram to identify signal interference easily and quickly. Time cursor and Marker enable time and frequency tracking for the intermittent interference signals.

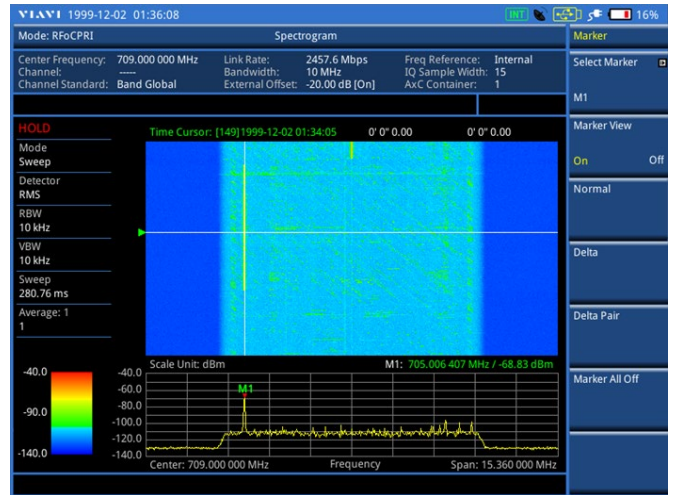

RFoCPRI — Spectrogram

Spectrum Replayer enables users to replay a recorded baseband spectrum achieved over CPRI link to better understand the nature of interference signal under investigation.

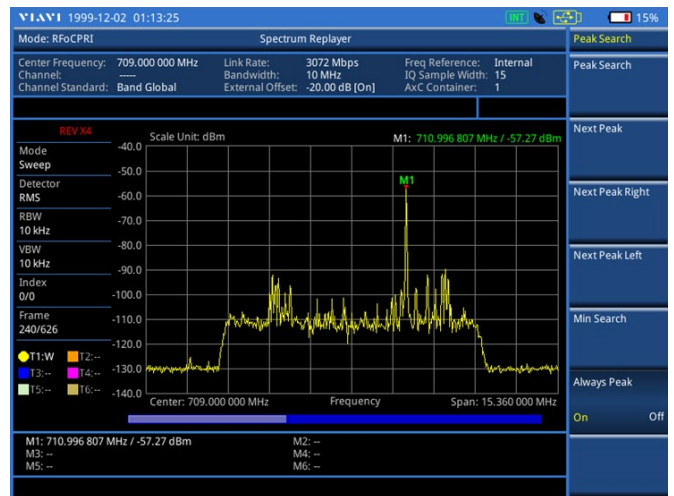

RFoCPRI — Spectrum Replayer

PIM Detection enables PIM detection on the radio system uplink. PIM detection can be achieved differently based on the number of radios that share the same RF/coaxial antenna system. Users can easily check the PIM generated by a single radio occupying wide band or multiple radios with different frequencies.



RfocPRI — PIM Detection - Single Radio

Channel Scanner

The Channel Scanner function (option 012) can measure up to 20 independent channels for any cellular technology at any channel or frequency. It also shows the power level for each signal type.



Channel Scanner

StrataSync*

The CellAdvisor JD780A-series analyzers are compatible with the Viavi cloud-based StrataSync™ solution to manage instrument inventory, to locate each piece of equipment, and to identify which engineer is using it. StrataSync also helps to keep instruments current through remote upgrades to ensure all instruments have the latest firmware. It also centralizes configuration setting and distribution to ensure that engineers are using the same instrument settings to achieve consistent measurements. Once testing is complete, measurement results can be uploaded into StrataSync for secure storage and sharing. Engineers who are unable to resolve a problem can share measurement results with an expert to get analysis help from anywhere without having the expert be near the instrument.

- Manage asset inventory
- Remotely distribute instrument upgrades
- Centralize configuration sharing
- Offers test data management
 - Trace files
 - Screenshots
 - Remote analysis



Bluetooth Connectivity

Bluetooth connectivity (option 006) provides safer and easier long-distance testing with the instrument housed at the top of the tower and controlled remotely via Bluetooth. Tests are conveniently made from the ground. Users can also transfer files from the instrument using file transfer. They can also tether the instrument to an Android smartphone or tablet with a data service connection to upload or download data to StrataSync.



Bluetooth connectivity

* CellAdvisor JD786B only

GPS Receiver and Antenna

The GPS receiver (option 010) gives the location (latitude, longitude, and altitude) and timing for highly-accurate frequency measurements to independently verify base-station timing.



Analyzer with GPS antenna

Application Software

JDViewer Features

- Communicates with the analyzer via LAN or USB
- Retrieves measured or saved measurements
- Exports measurement results
- Generates and prints configurable reports
- Creates a composite file of multiple spectrogram traces
- Analyzes measurement results allowing for assignment of multiple markers and limit lines
- Creates user-defined settings for channel power, occupied bandwidth, SEM, and ACLR
- Registers and edits user-definable cable types and frequency bands
- Creates automatic testing scenarios for GSM, CDMA/EV-DO, WCDMA/HSPA+, Mobile WiMAX, and LTE
- Creates signal strength maps as well as over-the-air signal analysis maps for GSM, CDMA/EV-DO, WCDMA/HSPA+, Mobile WiMAX, and LTE

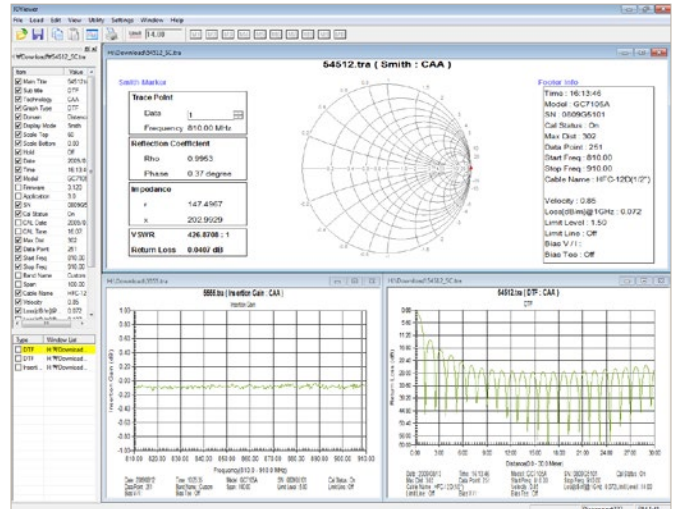

JDViewer VSWR, DTF, Smith chart



JDViewer OTA mapping

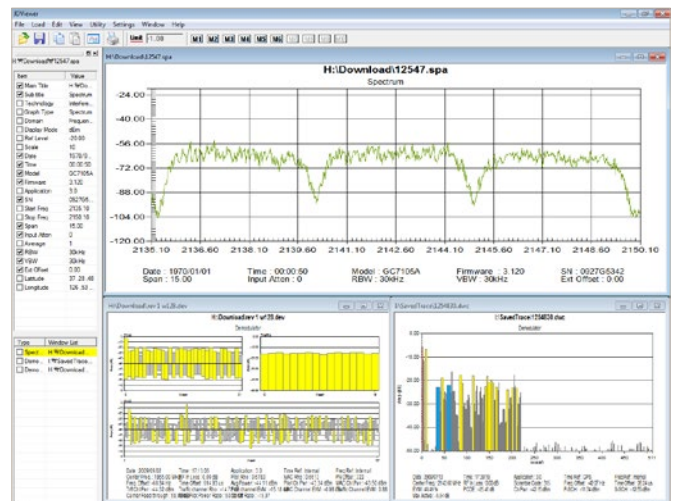

JDViewer spectrum, demodulation

JDRemote Features

This capability permits full remote control of the instrument through a software client. Control can either be via directly connected USB, network LAN connections, or Bluetooth.

The analyzer communicates with two Windows-based applications:

- JDViewer — for post-processing, report generation, personalized settings, and coverage map creation
- JDRemote — for full remote control



Analyzer with JDRemote